



 **SYNERGISED™**
INNOVATIVE DECKING SOLUTIONS



WORKING WITH ALUMINIUM & PORCELAIN



Synergised™ Decking Solutions

As part of our Synergised decking system we offer two high quality, cost-effective and non-combustible decking solutions that will help transform any decking or patio area. Both systems are easy to install and are suitable for domestic and commercial environments. And, whichever decking solution you choose, our unique innovative perimeter base system will allow for a wide range of our base fix handrailing solutions to be bolted down to the perimeter, providing a safe edge protection where there is a fall of more than 600mm.

Porcelain Tiles

La Fabbrica collection of porcelain stoneware reaches new heights in style and engineering, mimicking all the beauty and charm of the finest timbers. Safe, sustainable, versatile and refined, Italian excellence with unbeatable quality. 2 stunning collections each consisting of 5 colours, these tiles will flow seamlessly from inside your house to outside, changing only the surface texture with the designs simulating the warmth and texture of wood. Whether on flat ground, a raised patio or high-rise balcony, you can now step out of your house onto porcelain tiles that look like natural wood and are non-combustible.

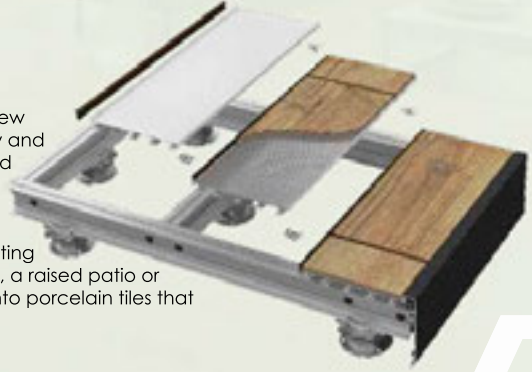

Aluminium Deck Boards

The Synergised range of aluminium deck boards has been tested by the UK's leading fire test centre to EN 13823, EN 13501 and EN ISO 1716. All elements of the Synergised aluminium deck system achieve Euroclass Classifications of A1 and A2fl-s1. Available in 3 contemporary colours and manufactured from structural grade 6063 T6 aluminium with a 100 micron Qualicoat™ premium powder coating, these are the ideal decking solution for both residential and commercial high footfall environments such as high rise balconies, walkways, terraces, pubs, gardens and many more. Installation couldn't be easier with our innovative cradle base and joist support system that offers up to 50% cost savings compared to other solutions. Once installed, the system is long lasting and low maintenance with a manufacturer's limited warranty.

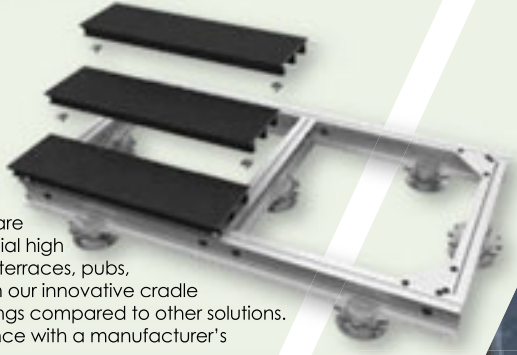

About us



For over 130 years fabricators, building contractors and specifiers have trusted F.H. Brundle to supply their product requirements. Collaboration between the in-house design team and experts have resulted in A1 and A2fl-s1 fire rated aluminium deck boards and non-combustible porcelain tile systems now being available.



Porcelain Tiles



Aluminium Deck Boards

Synergised™ Porcelain Tiles for Balconies and Terraces

Our fully non-combustible porcelain tiles system is ideal for all types of decking and raised patio applications including high-rise cantilever and pre-cast balconies. A dramatic reduction in hard landscaping costs allows you to build your dream elevated stone patio without the need for expensive retaining walls and tons of backfill materials.

Choose from 2 stunning collections each consisting of 5 colours. These tiles are an ideal solution for a myriad of applications. The tile design provides low surface temperatures underfoot.



Installation couldn't be easier, with tiles being installed directly onto a flat concrete floor or inserted into the tile trays for use with our Synergised subframe system.

Once installed the system is long lasting and low maintenance with a manufacturer's limited lifetime warranty on the tiles and a product life expectancy of 50 years plus.

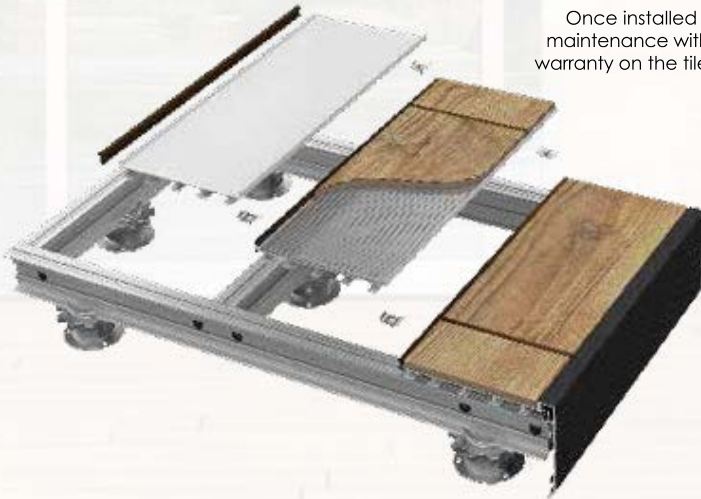

Easy to cut

- ◆ Stunning wood effect Italian porcelain from one of Italy's top design houses
- ◆ Non-combustible
- ◆ Low surface temperatures
- ◆ Ideal for elevated patios, all decking applications, and all types of balconies
- ◆ Build your dream elevated stone patio without the need for expensive retaining walls and backfill materials
- ◆ 1000mm joist spacing for 10mm tiles & tile support trays
- ◆ Dramatic reduction in hard landscaping costs
- ◆ Perimeter base section allows for our wide range of handrail systems to be fully integrated into your project

New raised patio



Existing subframe



Cantilever balcony



Concrete inset balcony



Why choose porcelain tiles?

When choosing a new or replacement deck, there will be several factors that influence your decision. Whereas in the past tiled patios required a hard landscaped surface, Synergised allows you to fit a suspended, safe tiled deck surface wherever you require without the mess and disruption caused by hard landscaping. The system offers unsurpassed looks, durability, and longevity, and is virtually maintenance free.



Key features of the Synergised porcelain tile system

Exceptionally cool underfoot

Fully non-combustible

Easily adjustable

Wide range of heights

High anti-slip rating

Made from quality porcelain

Adjustable cradle spacing up to 1800mm for 120mm joist

1000mm joist spacing for tile trays

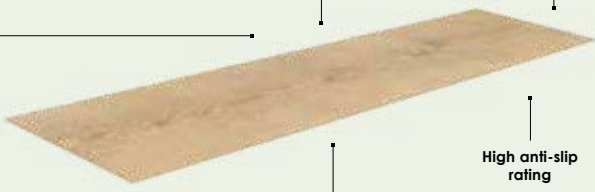

Fireproof



Stainproof



Easy to clean



Scratchproof



UV Resistant



Withstands sudden temperature change

The Synergised tile deck system can be retrofitted to existing subframes.



Porcelain Tiles

FREE SAMPLES AVAILABLE

La Fabbrica collection of porcelain stoneware reaches new heights in style and engineering, mimicking all the beauty and charm of the finest timbers. Safe, sustainable, versatile and refined, Italian excellence with unbeatable quality, the tiles will flow seamlessly from inside your house to outside, changing only the surface texture with the designs simulating the warmth and texture of wood. Whether on flat ground, a raised patio or high-rise balcony, you can now step out of your house onto porcelain tiles that look like natural wood and are non-combustible.

When fitting tiles to a cantilever balcony or structure with no floor or catchment underneath, the Synergised tile tray system offers a safe and practical solution, eliminating the risk of falling through a broken tile.

Features include:

- ◆ 2 collections and a choice of 5 colours in each
- ◆ Stunningly realistic natural wood effect
- ◆ Low maintenance & easy to install
- ◆ Anti-slip
- ◆ UV resistant
- ◆ 100% recyclable
- ◆ Low surface temperature
- ◆ Ideal for elevated patios & balconies
- ◆ Non-combustible
- ◆ Matching bronze effect spacer bars



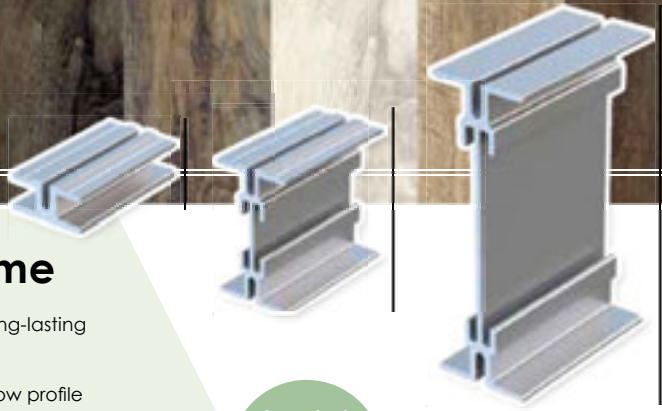

Synergised Subframe

A high performing subframe which is a long-lasting and durable alternative to timber.

The 20mm joist height allows for the ultra-low profile applications.

The aluminium joists are easy to cut, lightweight to handle and allow for quick and easy deck building.

Synergised subframe can be used with other deck materials.

Features include:

- ◆ Available in 3 heights
- ◆ Quick to assemble
- ◆ 3600mm lengths
- ◆ 1000mm joist spacing for tile trays
- ◆ Easy to cut
- ◆ Mill finish
- ◆ Lightweight
- ◆ Cradle spacing up to 1800mm with 120mm joist

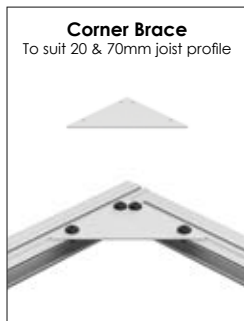
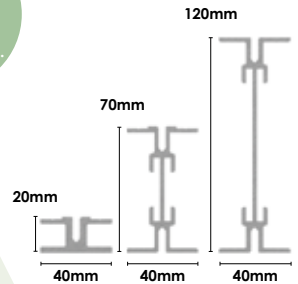

Synergised™ Deck Boards for Balconies and Terraces

Fully non-combustible fire rated A1 and A2fl-s1 aluminium decking system designed for both residential and commercial environments such as high-rise balconies, walkways, roof terraces, pubs, gardens and all other high-rise applications and public areas.

Available in 3 contemporary colours our deck boards are manufactured from structural grade 6063 T6 aluminium with 100 micron Qualicoat™ premium powder coating, making it the ideal decking solution for high footfall areas. The premium coating is low slip and provides low surface temperatures underfoot.



Installation couldn't be easier, with our innovative adjustable cradle base and joist support system that offers up to 50% cost saving compared to other solutions.

Once installed the system is long lasting and low maintenance with a manufacturer's limited warranty of 10 years on the coating with an expected product life expectancy 25 years plus.

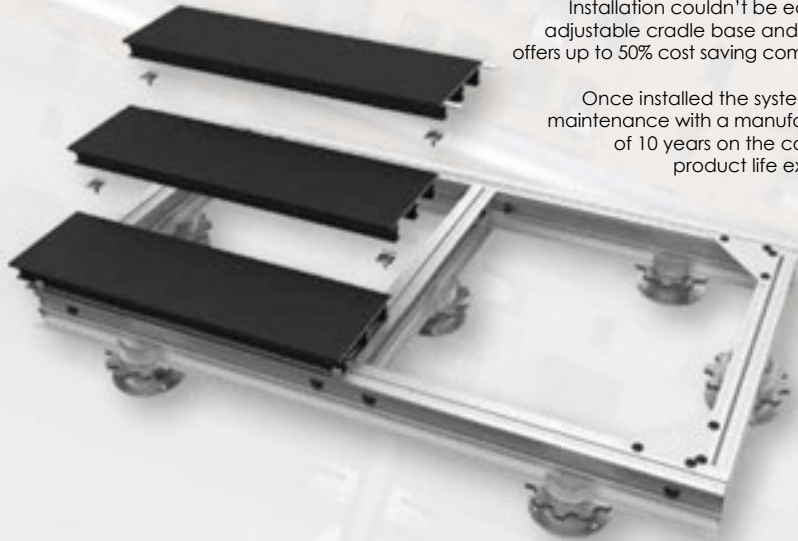

Easy
to cut

- ◆ Euroclass Classifications A1 and A2fl-s1 fire rated
- ◆ Made from structural grade 6063 T6 aluminium
- ◆ Ideal for high rise concrete balconies & terraces
- ◆ Up to 50% cost saving compared to other systems
- ◆ 100 micron Qualicoat™ premium powder coating
- ◆ Adjustable cradle and deck support system
- ◆ Low surface temperatures
- ◆ Long lasting and low maintenance
- ◆ Cradle spacing up to 1800mm with 120mm joist
- ◆ Lightweight and easy to install
- ◆ Mill finish subframes and cradles
- ◆ 10 year warranty on powder coating

Concrete balcony and terrace



By providing substantial height adjustment with 2 joist cradles and 3 joist heights, the support system was designed to make installation easier where there are height build ups on balconies and terraces.



Why choose aluminium boards?

When choosing a new or replacement deck, there will be several factors that influence your decision particularly the application and whether you require fire rated performance. Synergised is an innovative new aluminium deck system where the deck boards, subframe and adjustable cradles have been designed to replace non-fire rated products to provide peace of mind. The system offers unsurpassed durability and longevity, using 6063 T6 aluminium, 100 micron Qualicoat™ premium powder coating and mill finish.

Fire Rating

Synergised meets the requirements for any application that requires Euroclass Classifications A1 and A2fl-s1 fire rating, such as residential and mixed-use developments above 4 storeys, plus schools, universities, hospitals, libraries and care homes, as well as new or replacement decks on balconies that are above 11m in height.



Key features of the Synergised deck system

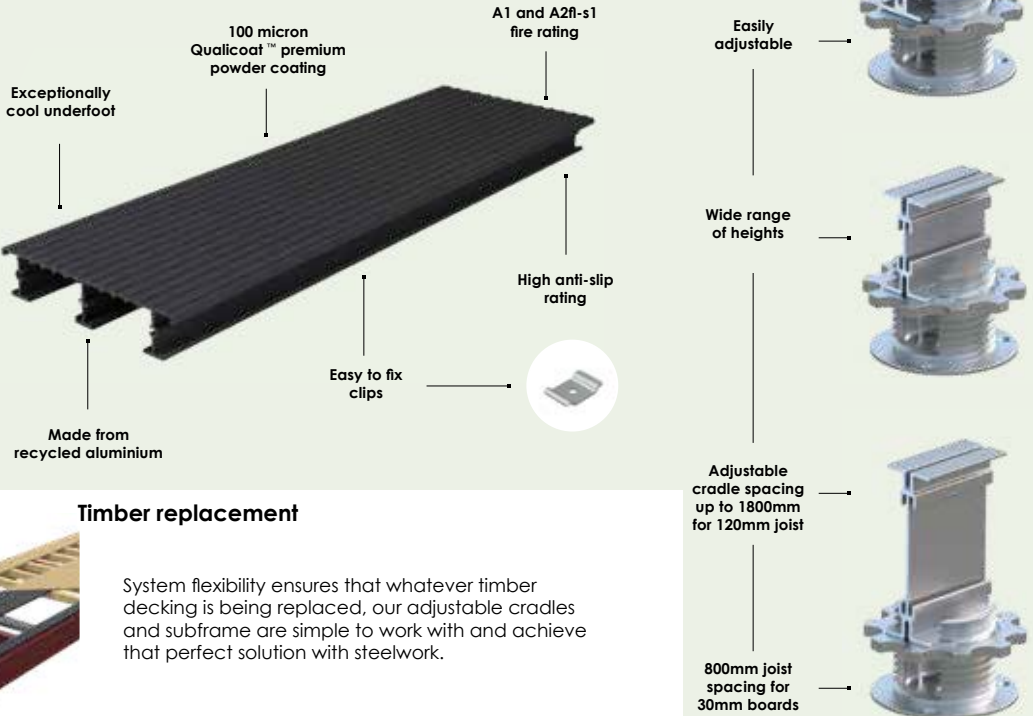

Timber replacement

System flexibility ensures that whatever timber decking is being replaced, our adjustable cradles and subframe are simple to work with and achieve that perfect solution with steelwork.

Synergised deck boards can be used with other subframe materials

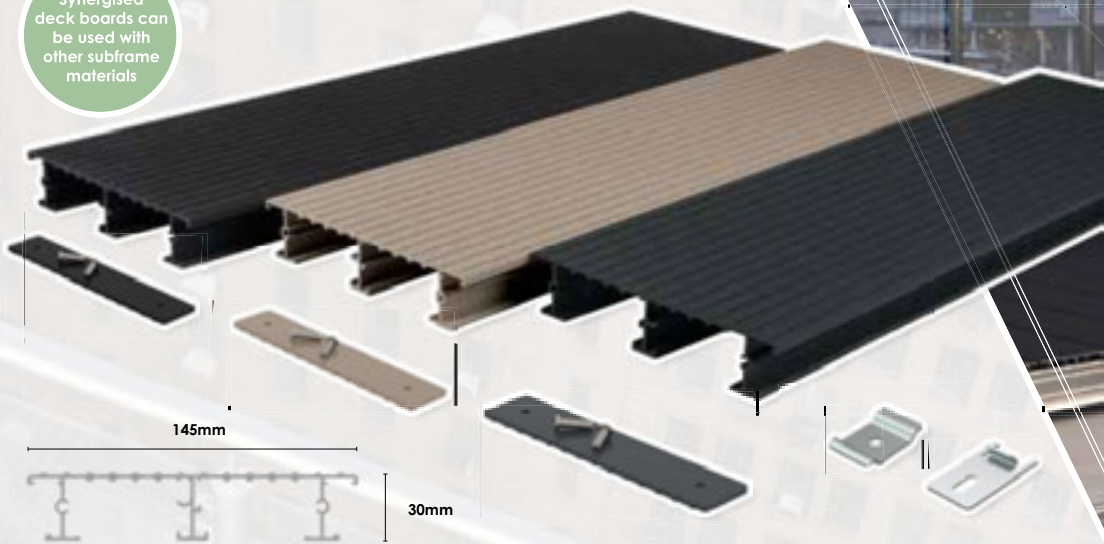

Synergised Deck Board

FREE SAMPLES AVAILABLE

Synergised high performance outdoor aluminium deck keeps looking great year after year. Enjoy the value of owning a deck with virtually no annual maintenance costs.

Available in 3 designer colours of Anthracite, Black and Serengeti Sand. The Qualicoat™ premium powder coat finish provides an extremely strong, UV stable surface finish. With excellent colour retention characteristics, Qualicoat™ premium powder coat ensures there are no before and after colour changes or fading, typically experienced with other deck products. The surface is comfortable on your feet, stays cool in the hot sun, is slip-resistant for added safety and security.

The hidden fastening system correctly spaces the decking boards for a consistent 5mm gap and easy installation.

Features include:

- ◆ 3 colours - Anthracite, Black & Serengeti Sand
- ◆ 100 micron Qualicoat™ premium powder coating
- ◆ Low maintenance & easy to install
- ◆ Anti-slip
- ◆ UV resistant
- ◆ 100% recyclable
- ◆ Low surface temperature
- ◆ End caps for a neat finish
- ◆ Matching deck trims available
- ◆ 5mm board spacing
- ◆ Lightweight and easy to handle
- ◆ Available in 3600mm lengths

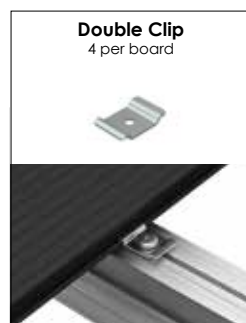
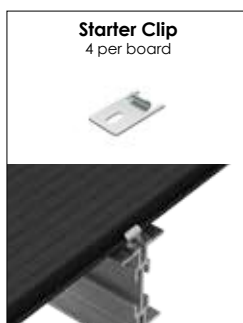

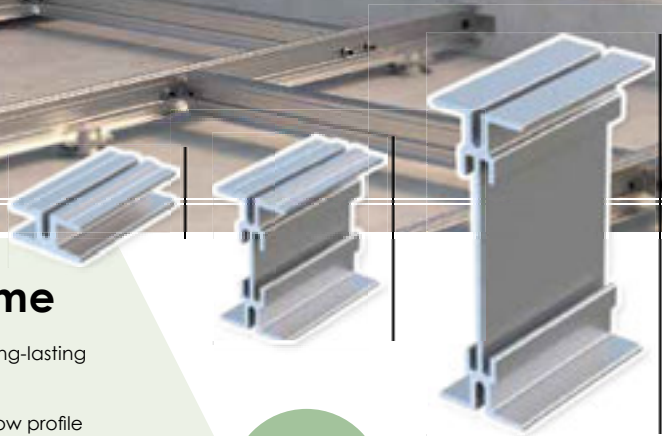

Synergised Subframe

A high performing subframe which is a long-lasting and durable alternative to timber.

The 20mm joist height allows for the ultra-low profile applications.

The aluminium joists are easy to cut, lightweight to handle and allow for quick and easy deck building.

Synergised subframe can be used with other deck materials.

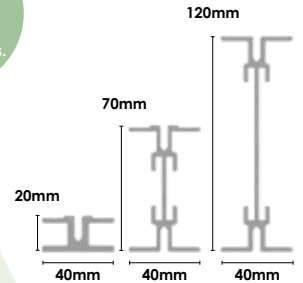

Features include:

- ◆ Available in 3 heights
- ◆ 3600mm lengths
- ◆ Easy to cut
- ◆ Lightweight
- ◆ Quick to assemble
- ◆ 800mm joist spacing for 30mm boards
- ◆ Mill finish
- ◆ Cradle spacing up to 1800mm with 120mm joist

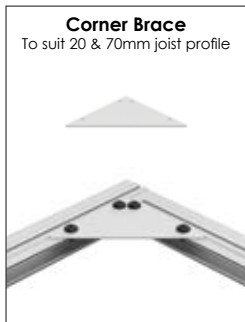

Synergised Aluminium Adjustable Cradle

These adjustable cradles are simple to install, with height adjustments ranging from 45 to 180mm, when combined with our joist profiles will ensure your deck is at the correct angle. Our innovative cradle base and joist support system offer up to 50% cost saving compared to other solutions.

The adjustable cradle has been designed by industry professionals to comply with Eurocode 1: Actions on Structures (BS EN 1991-1-1). The system has been assessed for point loading in relation to both domestic and commercial use, making it suitable for a range of applications.



45mm Adjustable Cradle

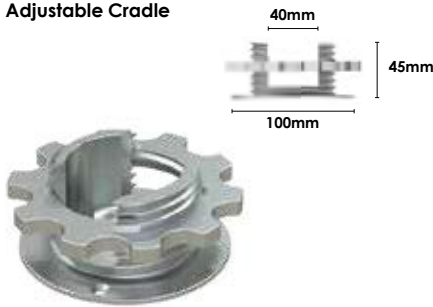

Minimum - Maximum Height

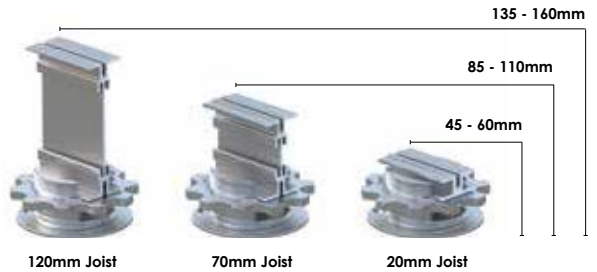

64mm Adjustable Cradle

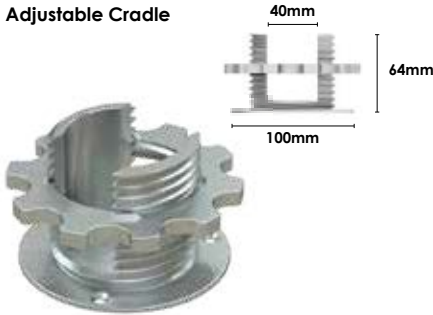

Minimum - Maximum Height



Features include:

- ◆ Easy to install
- ◆ Fully adjustable from 45 to 180mm
- ◆ Lightweight and easy to handle
- ◆ Mill finish



Synergised adjustable cradles can be used with other subframe materials

Synergised Perimeter Base System

Our unique innovative Perimeter Base Section, bolts directly to the Synergised subframe. It allows for a wide range of our base fix handrailing solutions to be bolted down to the perimeter, to provide a safe, stunning edge protection where there is a fall of more than 600mm. The Internal Perimeter Support Jack provides the strength required to allow handrailing systems to reach the desired residential 0.74kn loading requirements, as per BS6180.

If handrailing is not required, then our Edge Fascia Profile can be fitted to discreetly hide the subframe. The edge fascia profile is supplied powder coated black, to contrast stylishly with the range of porcelain tiles and handrailing solutions, it also perfectly matches the perimeter base section when used alongside on the same project.

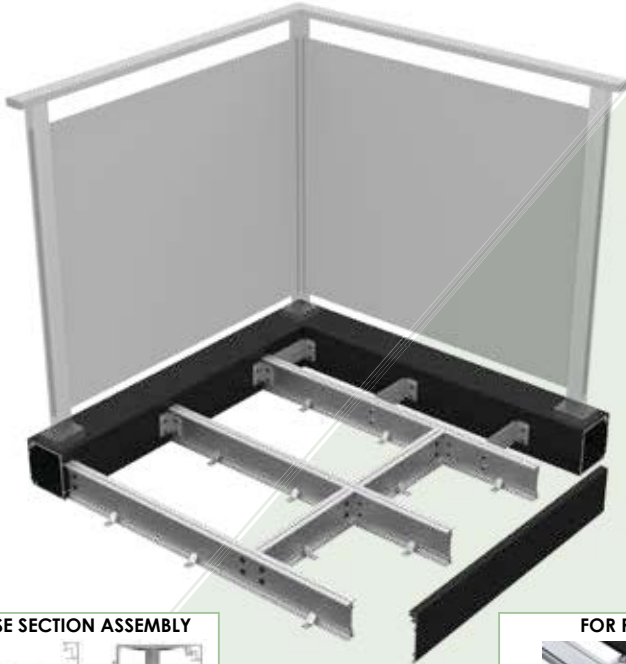

PERIMETER BASE SECTION ASSEMBLY

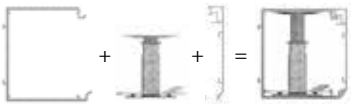

FOR RAISED SUBFRAMES



Perimeter Base Section

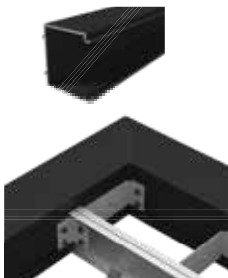

Internal Perimeter Support Jack

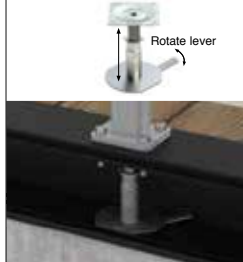

Edge Fascia Profile



Fascia Stand-Off Bracket

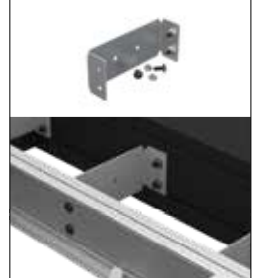

Synergised Perimeter Base System

Below you can see the true abilities of the Synergised range working to complement each other. The different facets of this system work together to provide a fully tested, low maintenance integrated decking and handrailing solution. The Synergised aluminium sub-frame provides the strength and loadings required to give the structure a strong support for fixing the perimeter system or fascia. The perimeter system can work in conjunction with many different generic base fixed handrailing solutions to achieve the look you are after, whilst at the same time providing a sturdy structure on which to fix your choice of stunning wood effect porcelain tiles or aluminium deck boards.

PERIMETER BASE SECTION



PERIMETER BASE SECTION ASSEMBLY

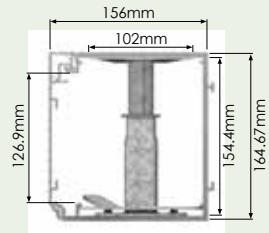

Steel



Aluminium



Spigots

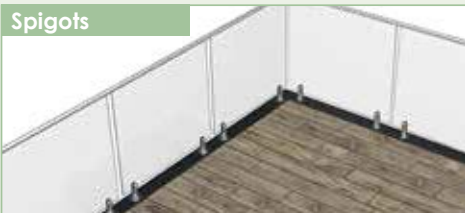

Frameless



Technical Specification

Porcelain Tiles

◆ All tests have been performed to ISO 1045/ 1 - 14

Water absorption

Test Method	Fixed value
ISO 10545-3	≤ 0.5%

Modulus of rupture

Test Method	Fixed value
ISO 10545-3	≤ 7.5mm:min 1300 N < 7.5mm:min 700 N

Stain resistance

Test Method	Fixed value
ISO 10545-14	–

Friction coefficient (slipperiness)

Test Method	Fixed value
ANSI A 137.1:2012	≤ 0.42

Breaking modulus

Test Method	Fixed value
ISO 10545-4	35 N/mm ² = 356 Kg/cm ²

Deep abrasion resistance

Test Method	Fixed value
ISO 10545-6	≤ 175mm ³

Colour stability to light

Test Method	Fixed value
DIN 51094	–

5kN/m2 Distributed Load @ 1/480 Deflection Criteria.

Description	Cradle Support Spacing (mm)
120mm joist	1800
70mm joist	1100
20mm joist	500



Fireproof



Stainproof



Easy to clean



Scratchproof



UV Resistant



Withstands sudden temperature change

Aluminium Decking

- ◆ Anti-slip pendulum test to BS7976-2 dry and wet
- ◆ Reaction to fire performance (A1 and A2fl-s1) in accordance to EN 13823, EN 13501 and EN ISO 1716

Tested for commercial applications

5kN/m2 Distributed Load @ 1/480 Deflection Criteria.

Description	Cradle Support Spacing (mm)
120mm joist	1800
70mm joist	1100
20mm joist	500

Description	Joist Spacing (mm)
30mm board	800

Pendulum test results

Dry test

Sample Code	Mean Resistance Operator 1	Mean Resistance Operator 2
1	65	63
Product mean	64	
Product minimum	63	
Product maximum	65	
Standard deviation	1	

Deck board temperature comparison chart

Ambient temperature 31° Celsius.

Description	Max Temperature °Celsius
30mm Aluminium Serengeti Sand	43
30mm Aluminium Anthracite	49
30mm Aluminium Black	50
23mm Cedar hollow composite	54
23mm Anthracite hollow composite	55
23mm Grey hollow composite	55
38mm Cedar stained softwood	57

Tested with handheld infrared thermometer in direct sunlight.

Wet test

Sample Code	Mean Resistance Operator 1	Mean Resistance Operator 2
1	50	48
Product mean	49	
Product minimum	48	
Product maximum	50	
Standard deviation	1	

FULL TECHNICAL INFORMATION ON OUR SYNERGISED™ RANGE IS AVAILABLE ONLINE.



SYNERGISED™

INNOVATIVE DECKING SOLUTIONS

Email: synergised@brundle.com

Website: www.fhbrundle.co.uk

London

T: 01708 253545

E: sales@brundle.com

Southampton

T: 023 8070 3333

E: southampton@brundle.com

Glasgow

T: 0141 773 6699

E: glasgow@brundle.com

Ilkeston

T: 0115 930 2070

E: ilkeston@brundle.com

Birmingham

T: 0121 565 8282

E: birmingham@brundle.com

Newton-le-Willows

T: 01942 868888

E: haydock@brundle.com



24/7 ONLINE
ORDERING



COMPETITIVE
PRICES



HUGE RANGE
FROM STOCK



FREE DELIVERY
OVER £150



TRADE COUNTER
COLLECTION



BRANCHES
ACROSS THE UK

